







BEFORE YOU START

Please check the parts list before installation to ensure all parts are present. If there is anything missing or damaged, please directly contact us by e-mail for replacement parts.



Participant: 

Required tools: Allen Wrench

A		M6*10 X 9	B		M6*25 X 3	C		D13*1.5 X 3
D		M4 X 1	E		∅19*15*M6 X 3	F		D10*1.5 X 4

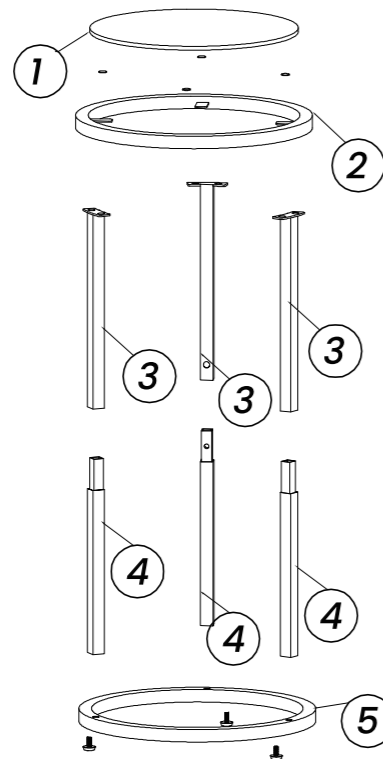

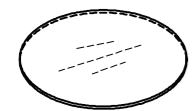
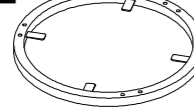
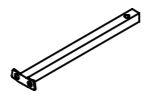
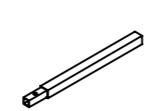
Allen Wrench



1		1PCS	2		1PCS	3		3PCS	4		3PCS	5		1PCS
----------	---	------	----------	---	------	----------	---	------	----------	---	------	----------	---	------

STEP 1

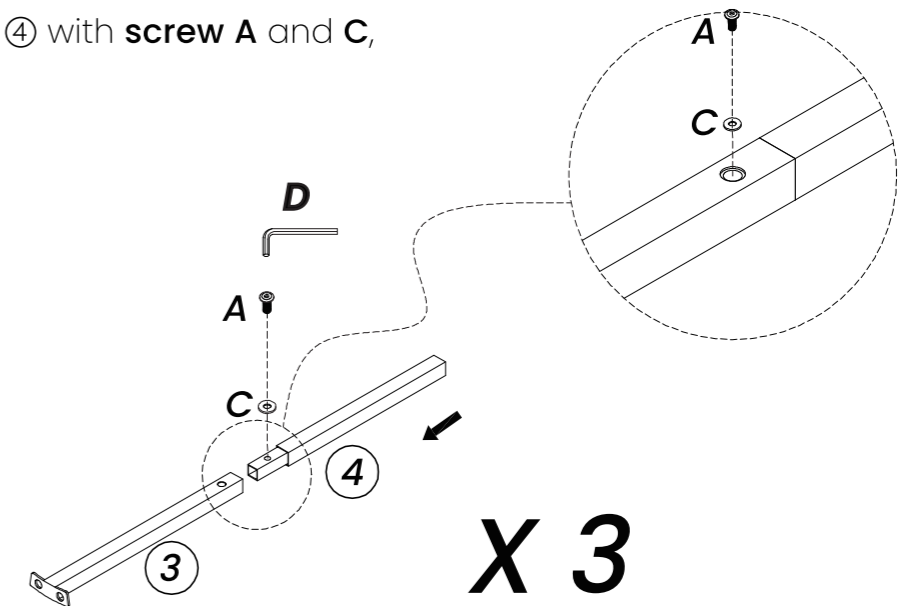

Please connect ③ to ④ with **screw A** and **C**,

A		M6*10 X 3
C		D13*1.5 X 3
D		M4 X 1



STEP 2

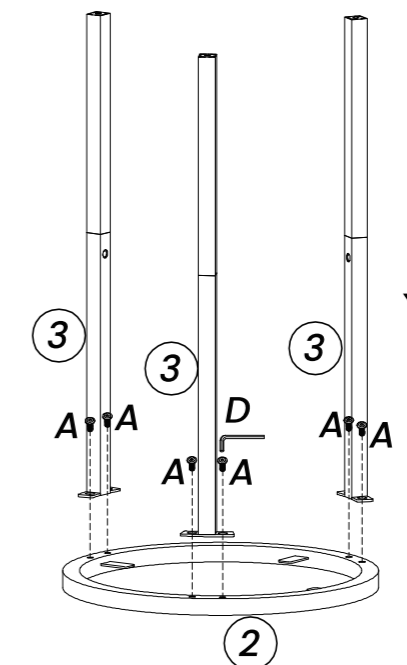

Please connect and **align** the ③ with ② -round frame, then insert the six **Screw A** into the holes on the frame.

A		M6*10 X 6
D		M4 X 1



STEP 3

Please connect and **align** the ④ with ⑤-round frame, then insert Screw **B** and **Screw E** through the holes

B		M6*25 X 3	D		M4 X 1
----------	---	--------------	----------	---	-----------

E		Ø19*15*M6 X 3
----------	---	------------------

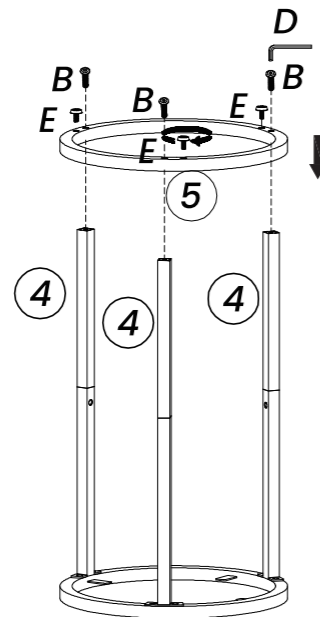

STEP 4

Please turn the table upside down and put the 4pcs silent gaskets onto the round frame ②, then put the glass ① onto the support frame carefully.

F		D10*1.5 X 4
----------	---	----------------

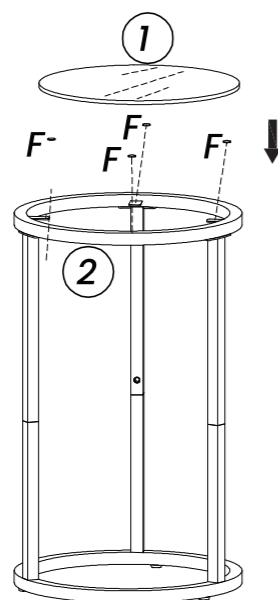

FINISH

Note: A Gentle Reminder.

In daily use, do not put any sharp or rough things directly on the glass top for a longer using life.

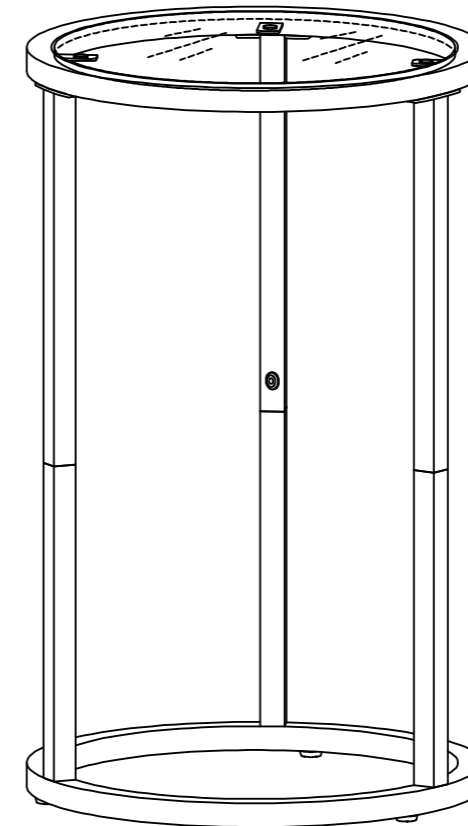

Enjoy your new glass end tables.